

INSTRUCTION MANUAI FOR FOLDABLE BASKETBAII STAND SG-2



Very Important!!!

*All the basketball system, including those used for displays, must be assembled and ballasted according to instructions. Failure to follow instructions could result in serious injury. Please read warnings and cautions carefully before assembly.

* The weight rack must be put 300kgs at least for stability before using.

* Double check the springs (F) and it's connecting parts before folding and moving. THE UNEXPECTED BROKEN OF SPRING (F) MAY CAUSE SERIOUS INJURY AND DEATH.

*This product is to be assembled by 4 adults at least. please prepare one strong ropes and two wren

Parts list

Part No.	quantity	Name	Notes
A1	10	SCREW M10*65MM	*8pcs: each contains 1 washer, *2pcs: each contains 2 washers and 1 nut.
A2	2	SCREW M8*45MM	each contains 1 washer
A3	4	SCREW M16*55MM	each contains 2 washers and 1 nut
A4	2	SCREW M16*115MM	each contains 2 washers and 1 nut
A5	1	SCREW M12*110MM	each contains 2 washers and 1 nut
A6	1	SCREW M12*140MM	each contains 2 washers and 1 nut
A7	1	SCREW M12*70MM	No washer and nut
A8	4	SCREW M10*40MM	each contains 2 washers and 1 nut
A9	1	SCREW M16*160MM	each contains 2 washers and 1 nut
A10	2	SCREW M10*50MM	each contains 2 washers and 1 nut
B	2	Base bracket	One left and one right
C1	2	Lower base beam	Width 40x80mm
C2	1	Upper base beam	Width 30x50mm
D	1	Spring pulling rod	
E	2	Spring locating screw	Equipped with a diameter of 18mm Nut and a gasket.
F	6	Spring	
G1	1	Front bracket	
G2	1	Rear bracket	
H	1	Main pole	
I1	1	Up lift rod	Diameter:45mm
I2	1	Lower lift rod	Diameter:50mm
J	2	Backboard support pole	One left and one right
K	1	Backboard	
L	1	Rim	
M	1	Fixing block	
N	1	net	
O	1	Front pad	
P	2	Side pad	One left and one right
Q	1	Rear pad	
R	1	Upper pad	
S	1	Cover pad	Optional part
T	1	weight rack	

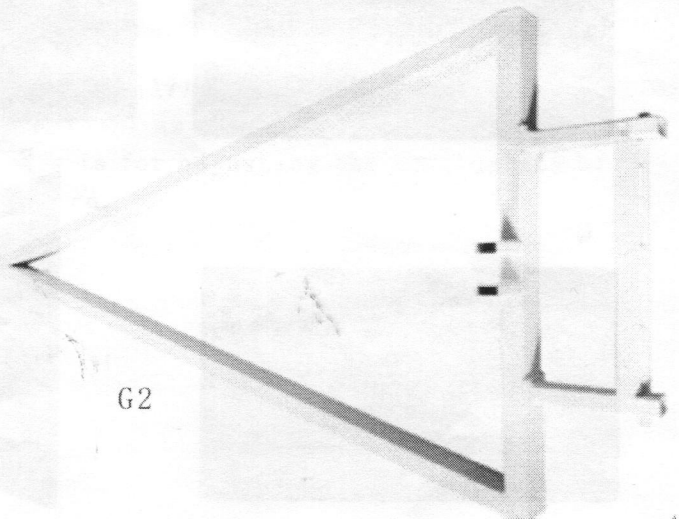
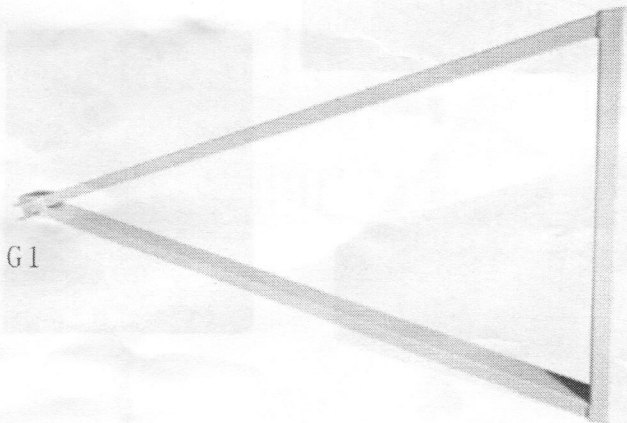
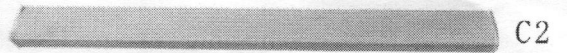
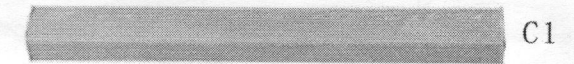
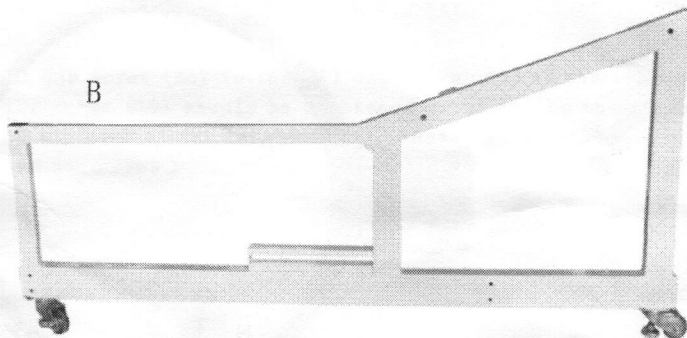
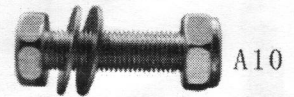
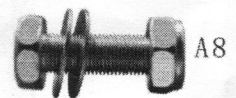
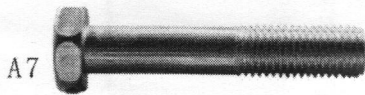
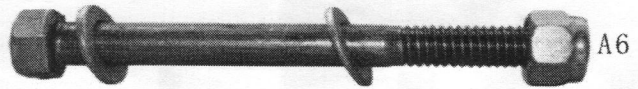
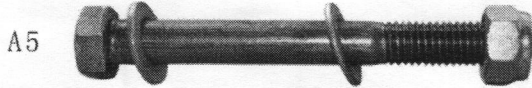
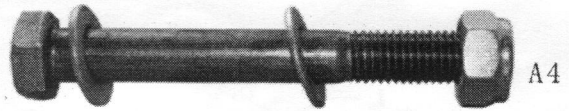
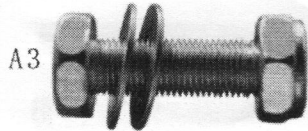
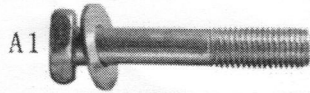

REAR

SBA305

H

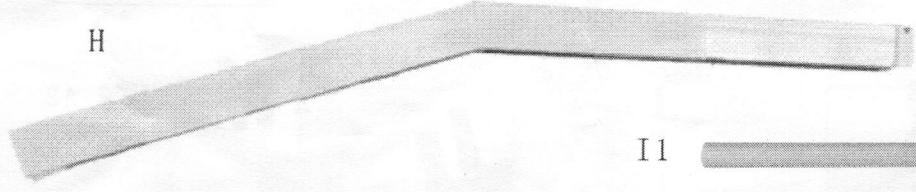

I1



I2



J



K

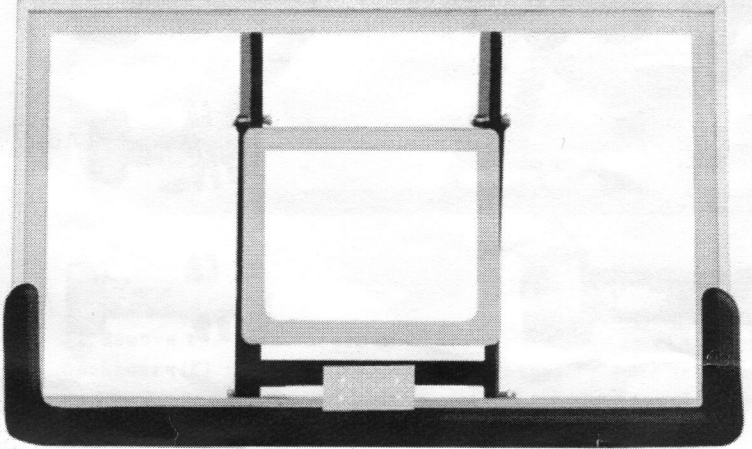

M

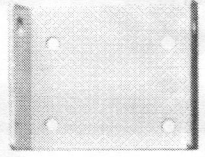

T

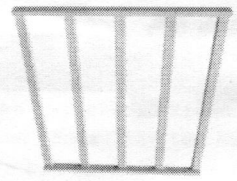

N

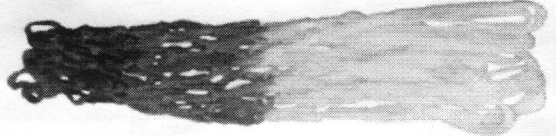

L

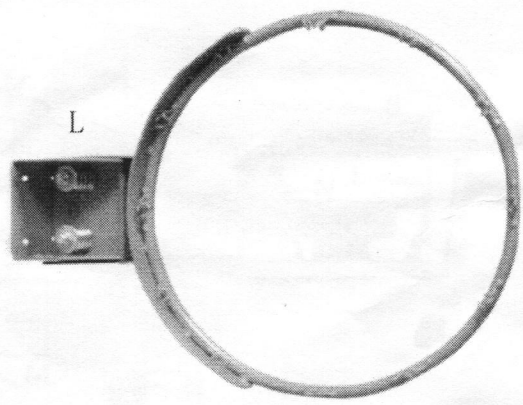

O



P

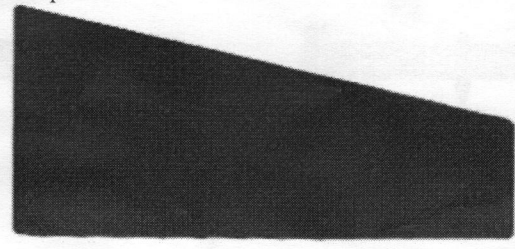

S

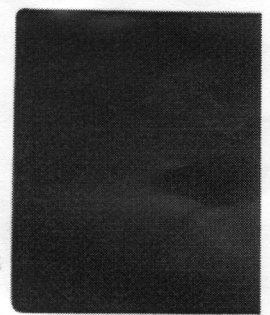

Q



R

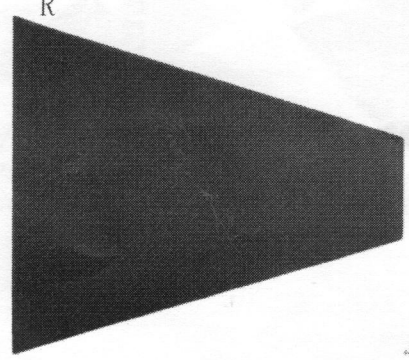

ASSEMBLY STEPS:

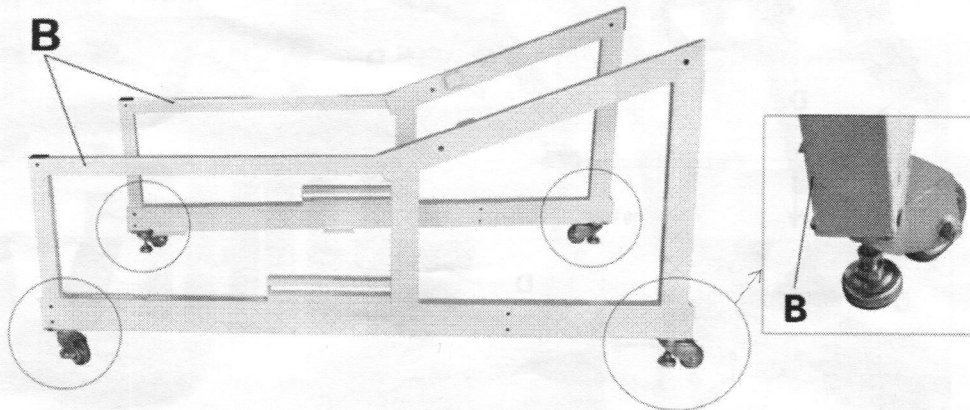

1. Install the 2 base brackets (B) as shown, fix all the four casters under the 2 base brackets (B). In order to prevent sliding while installing and using, the front two casters are with foot, the

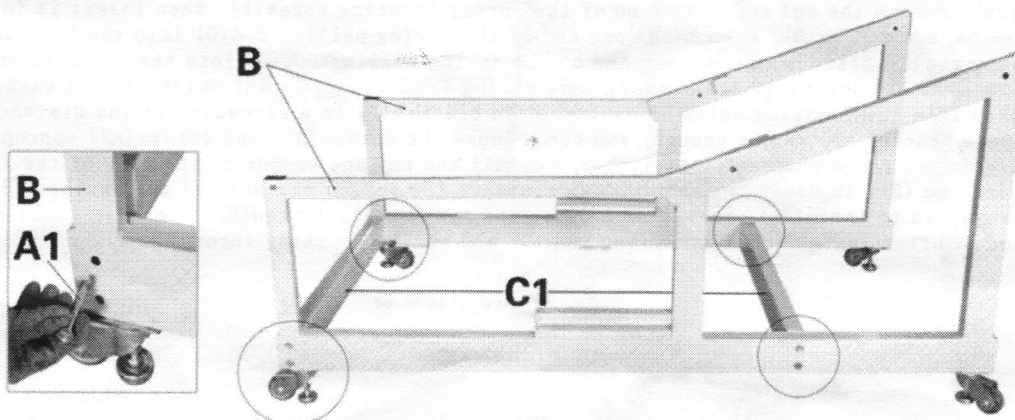

2. Fix two lower base beam (C1) between the 2 base brackets (B) by 8pcs screws (A1) as shown. Notice: Do not tighten screws (A1) completely this time, leaving clearance for the 4th assembly step of spring pull rod (D) and spring locating screw (E) installation.

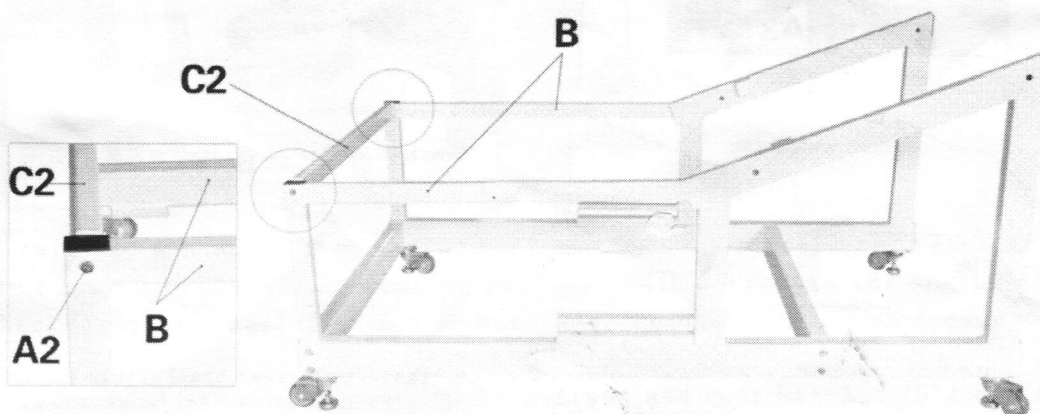

3. Fix the upper base beam (C2) between the 2 base brackets (B) by 2pcs screws (A2) as shown. Notice: Do not tighten screws (A2) completely this time, leaving clearance for the 4th assembly step of spring pulling rod (D) and spring locating screw (E) installation.

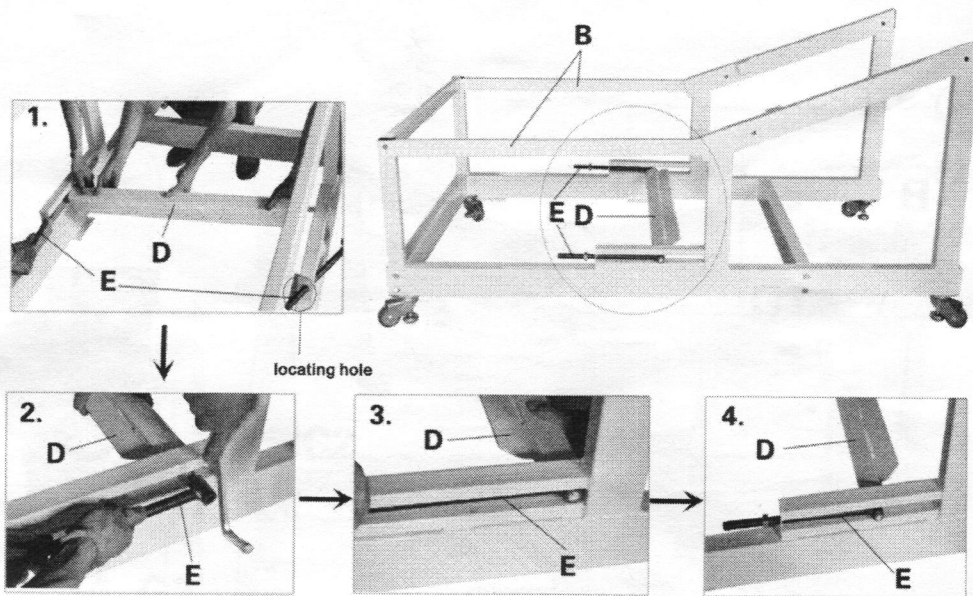

4. Install spring pulling rod (D) and spring locating screw (E) on the base bracket (B) as shown.
 1) First, remove the nut and washer on of the spring locating screw (E), then insert it into the hole on one base brackets (B), then knock one end of the spring pulling rod (D) into the hole of this spring pulling rod (E). 2) knock the another end of the spring pulling rod (D) into the end hole of another spring locating screw (E), then insert this spring locating screw (E) which nut and washer has been removed into the locating holes of another base bracket (B) in a sideways. If the distance between the two base bracket (B) is not enough, you can loose the screws (A1) and screws (A2) appropriately, please do not force the beat. After that, install the nut and washer on the ends of the 2pcs spring pulling rod (E), in order to leave enough distance for follow assembly of the springs (F), the nuts is suggested to install 1 centimeter only on the spring pulling rod (E). Finally, tighten the screws A1 and A2 after Install spring pulling rod (D) and spring locating screw (E).

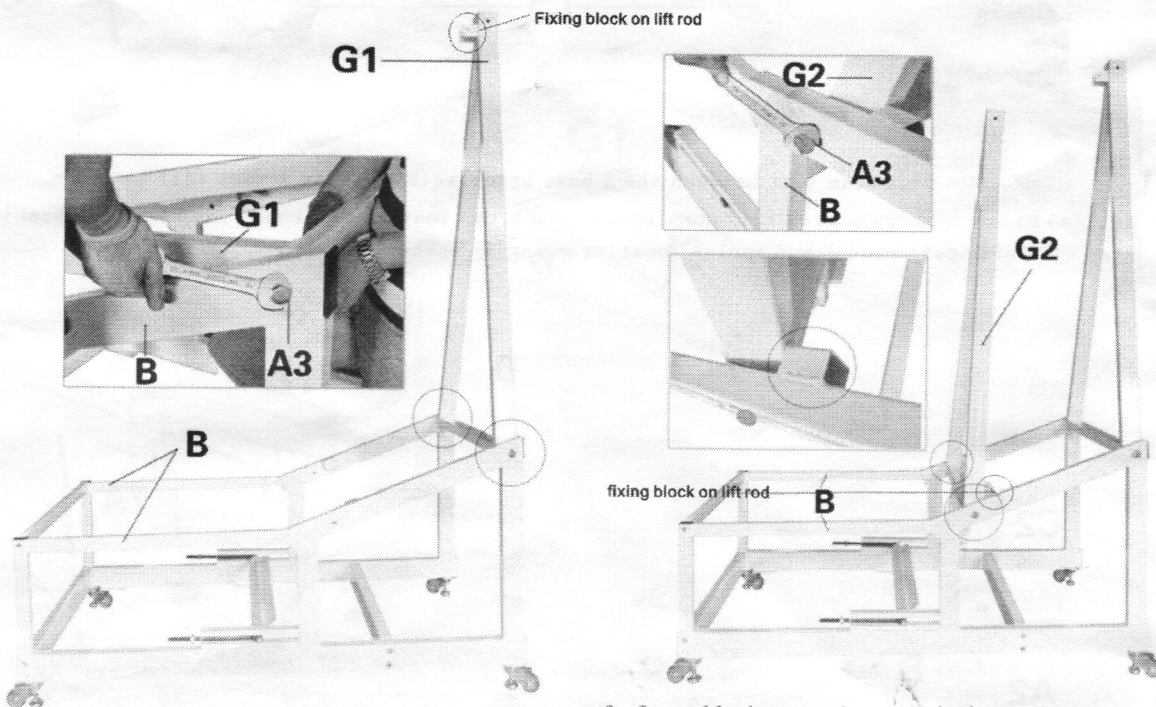

5. Fix the front bracket (G1) on front top of the base brackets (B) with 2pcs screws (A3) as shown. Please make sure the fix block on the top of front bracket (G1) is facing the rear.

6. Install the rear bracket (G2) on the two base bracket (B) with 2pcs screws (A3) as shown, please make sure the fix block on the bottom of rear bracket (G2) is facing front for following upper lift rod (I1) and lower lift rod (I2) assembly. (Remarks: on each side of the base bracket (B) there is one block, in order to prevent the rear bracket (G2) fall forward.)

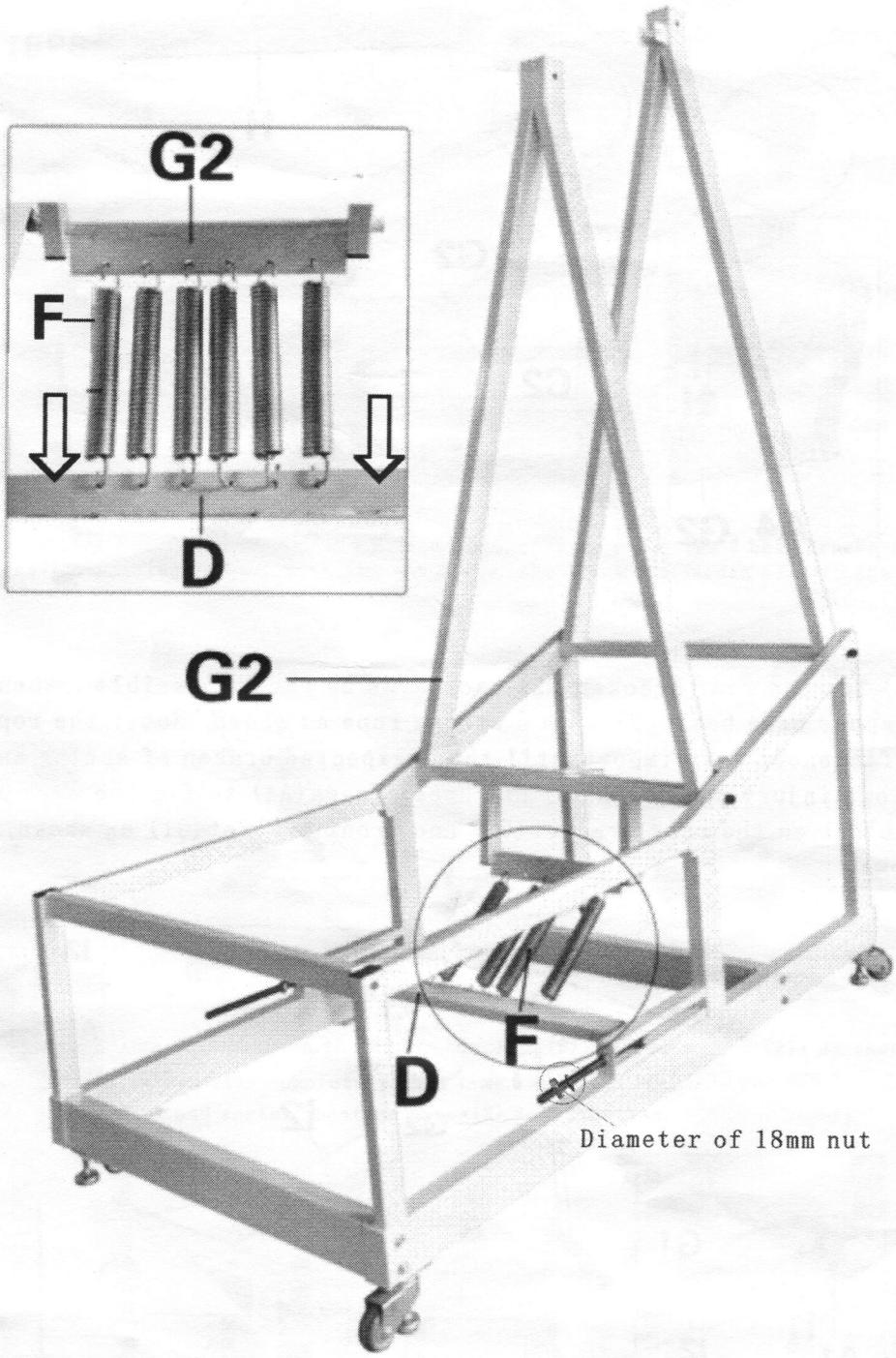

7. Install the springs (F) as shown: Hook the 6pcs springs(F) on reserved springs holes of rear bracket(G2) and spring pulling rod(D). Promote the spring pulling rod (D) backwards in parallel as far as possible, tighten the nut on Spring pulling rod(E)

Note: two adults are required to hold the front and rear bracket (G1) and (G2) when installing the springs, so as not to fall down and hurt somebody.

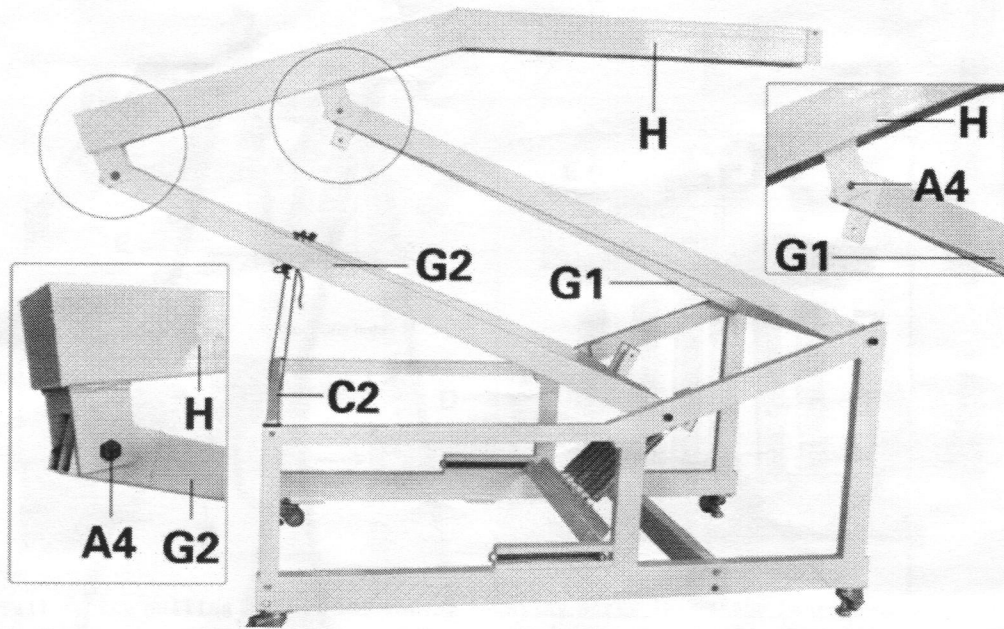

8. 1) Tug the rear bracket (G2) backwards as far as possible, then, tie it to the upper base beam (C2) with a strong rope as shown. Note: the rope must be stout and fastened. Very important!! the unexpected broken of spring and rope may cause serious injury and death. 2) Use 2pcs screws (A4) to fix the main pole (H) on the fix block on the rear bracket (G2) and front bracket (G1) as shown, then tighten the screws

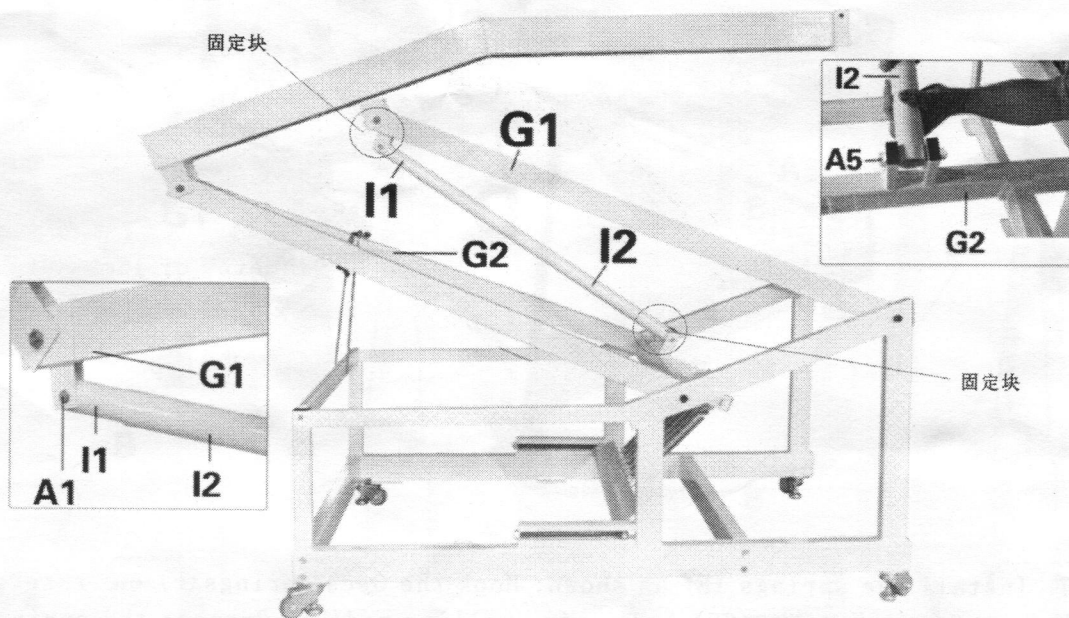

9. Use screw (A1) to fix the up lift rod (I1) to the fix block on the upper end of the front bracket (G1) as shown, then insert the front bracket (G1) into the lower lift rod (I2). After that, use screw (A5) to fix the lower lift rod (I2) to the fix block on the lower end of the rear bracket (G2). Finally, tighten the nut.

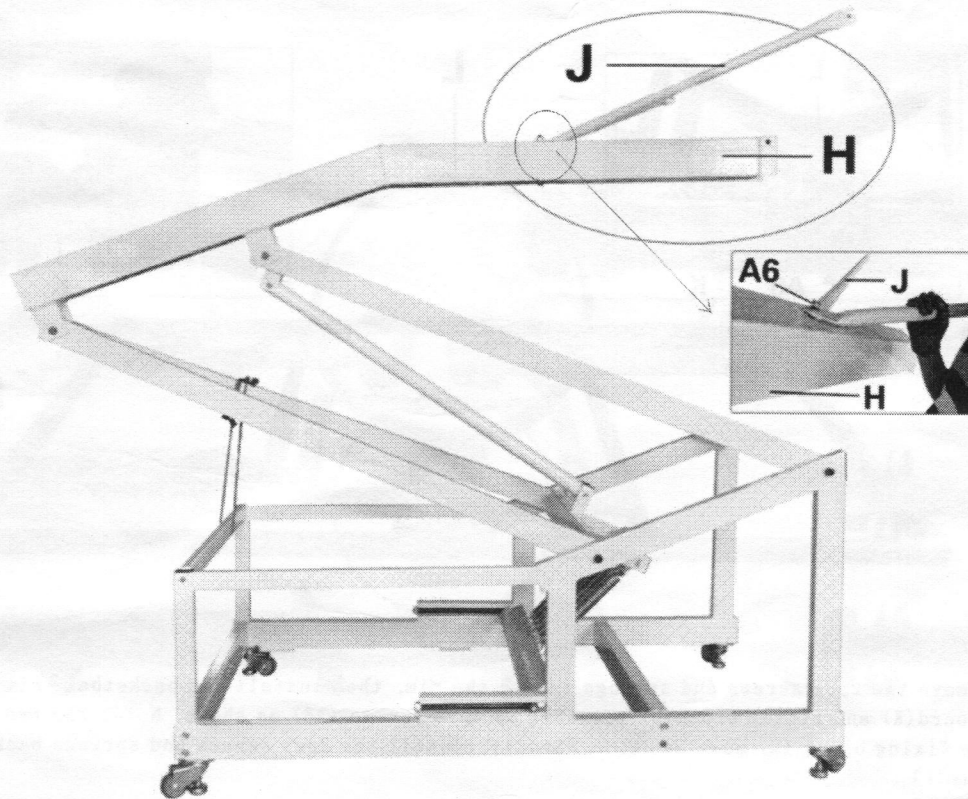

10. Use screw (A6) to install one longer end of two backboard support poles (J) on the main pole (H). The screw (A6) should be tightened after fixing the another end of the backboard support pole (J) on the back of the backboard (K), (Note: 2pcs backboard support poles (J) is divided into one left and one right)

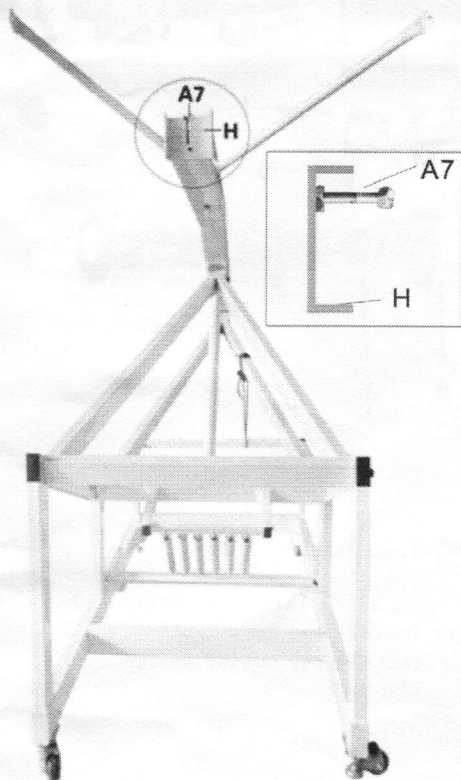

11. Insert screw (A7) into the hole on the front end main pole (H) as shown, tighten the screw (A7). This screw is for adjusting the verticality of the backboard.

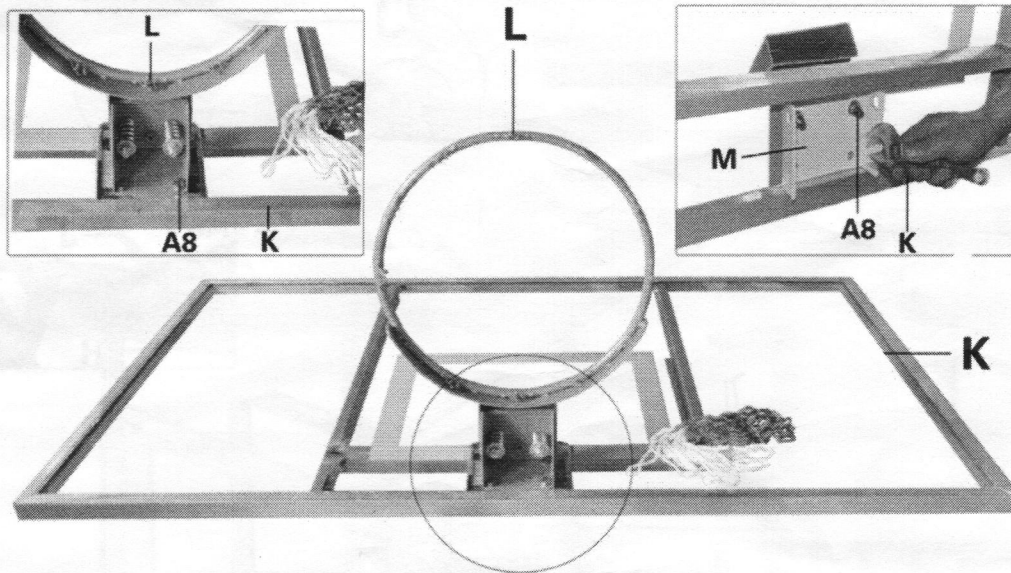

12. Remove the 2pcs screws and springs inside the rim, then install the basketball rim(L), backboard(K) and fixing block(M) together by 4pcs screws (A8) as shown. Note: the two holes on the fixing block (M) must be above. Finally, install the 2pcs screws and springs back to the rim(L) .

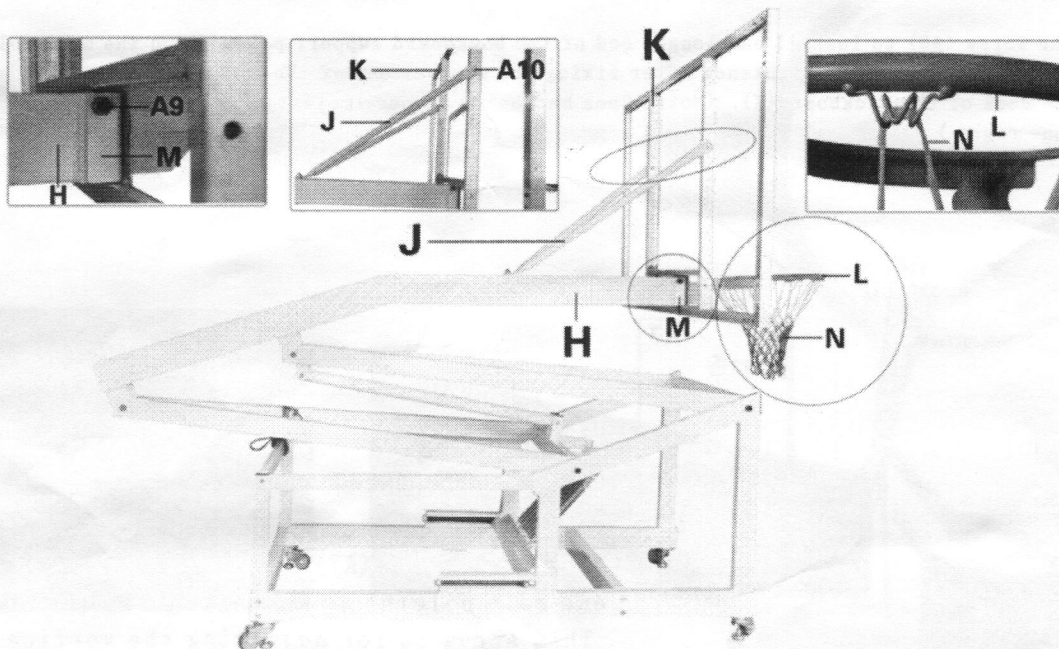

13. Lift the entire backboard, use screw(A9) to fix the fixing block (M) on the front end of the main pole(H) as shown, then use 2pcs screws(A10) to install the 2pcs backboard support poles(J) on the back of the backboard(K). finally, install the net(N) on the basketball rim(L).

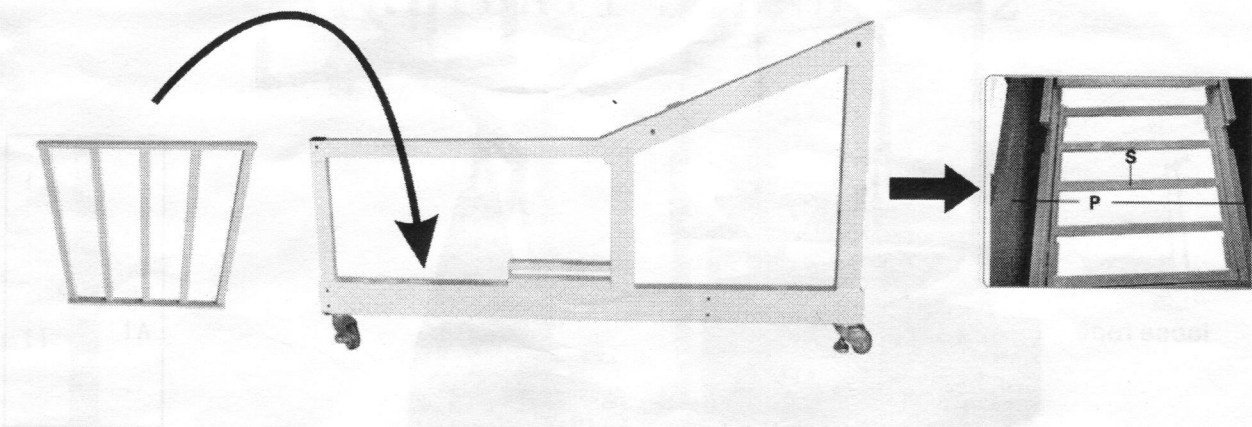

14. Put weight rack (T) into the fixing blocks on the base brackets (B) as shown, in order to keep balance of the entire basketball stand, the weight rack must be put with 350kgs for stability at least before using ,ensure that backboard will not forward.

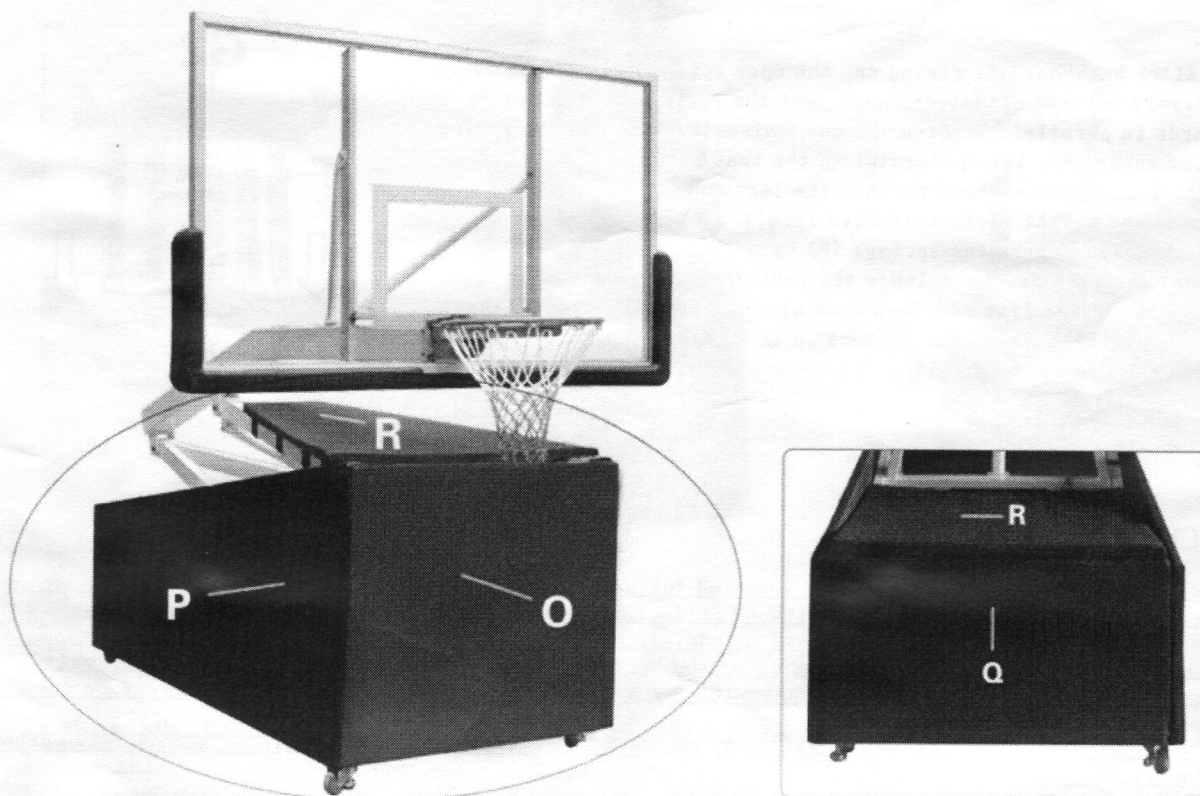

15. Fixed front pad (O), two side pads (P), rear pad(Q), upper pad(R) and cover pad(S) on the basketball stand as shown.



16. Loose the rope which is connected rear bracket (G2) and lower upper base beam (C2) slowly, until the front bracket (G1) and rear bracket (G2) getting vertical. When the fixing holes on the up lift rod (I1) and lower lift rod (I2) get overlapping, insert screw (A1) into the hole to fix the height of basketball stand.

17.1) After backboard (K) rising up, the 6pcs springs (F) will be in a relatively relaxed situation, need pull the spring pulling rod (D) backwards in parallel. Tighten the nut (diameter 18mm) on the spring locating screw (E), let springs (F) in the taut situation.
 2) tighten all screws, check whether the lift rod, backboard and weight racks installed firmly.
 3) Before moving, check the springs (F) carefully, hold the front and rear brackets, loose the screw (A1) which is connected up/lower lift rod, then down slowly, this step must be three adults to complete. when four casters is in an active condition, you can move the basketball stand.

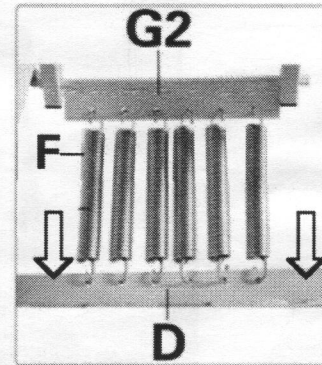

⚠ SAFETY WARNING

Owner must ensure that all players know and follow these rules for safe operation of system. To ensure safety, do not attempt to this system without following the instructions carefully. check entire box and inside all packing material for parts and/or additional instructions material, before beginning assembly, read the instruction and identify parts using the hardware identifier and parts list in this document. proper and complete assembly, use, and supervision are essential for proper operation and to reduce the risk of accident or injury.

A high probability of serious injury exists if this system is not installed, maintained, and operated properly. Very Important!!!

*All the basketball system, including those used for displays, must be assembled and ballasted according to instructions. Failure to follow instructions could result in serious injury please read warnings and cautions before assembly.

* The weight rack must be put 350kgs for stability at least before using.

* Double check the springs (F) and it' s connecting parts before folding and moving. THE UNEXPECTED BROKEN OF SPRING (F) MAY CAUSE SERIOUS INJURY AND DEATH.

*This product is to be assembled by 4 adults only. please prepare two strong ropes and wrench.

We appreciate your purchasing one of our many fine products. we are assure that you will be satisfied with your selection.